

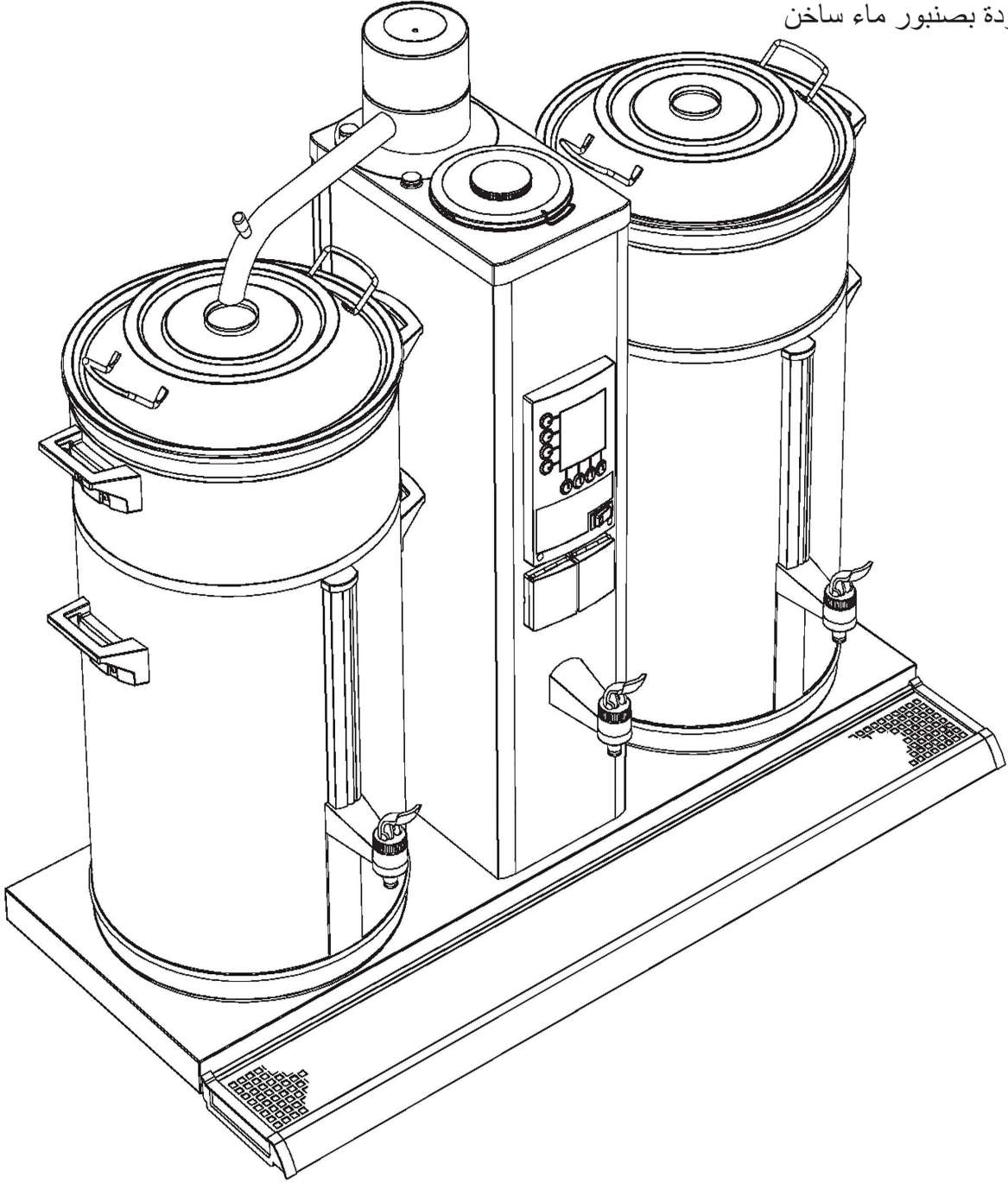























**BRIVILOR®**  
**BONAMAT**

## تعليمات التشغيل الصورة

ماكينة تحضير القهوة مستدير مزودة بمرشح  
مزودة بصنوبر ماء ساخن



طراز BHW-series

	English	العربية
.1	 Use	الاستخدام
	 Dripping	التقطير
.2	 Cleaning, frequently	التنظيف، بشكل متكرر
	 Wait	انتظر
	 Acoustic signal	الإشارة الصوتية
.3	 Descaling	إزالة التكلس
	 Read Operating Instructions	اقرأ تعليمات التشغيل
.4	 Descaling hot water system	إزالة تكلس جهاز الماء الساخن
	 Very hot	ساخن جدًا
.5	Initial use	الاستخدام الأولي
.6	Programming (operator)	البرمجة (المشغل)
	 Selection keys	مفاتيح الاختيار
	 Confirm	تأكيد
	 Cancel	إلغاء
	 Water hardness	تعسر الماء
	 Read Operating Instructions	اقرأ تعليمات التشغيل
.7	Programming (principal)	البرمجة (الأساسية)
	 Selection keys	مفاتيح الاختيار
	 Confirm	تأكيد
	 Cancel	إلغاء
	 Off	إيقاف تشغيل
	 Min.	دقيقة
	 Standard	قياسي
	 Max.	الحد الأقصى
	 Water hardness	تعسر الماء
	 Read Operating Instructions	اقرأ تعليمات التشغيل
	Hold 10 sec.	انتظر 10 ثوانٍ
Select desired time setting (1-14)	حدد إعداد الوقت المطلوب (1-14)	
.8	Error codes	رموز الخطأ

## 1. الاستخدام (BHW)

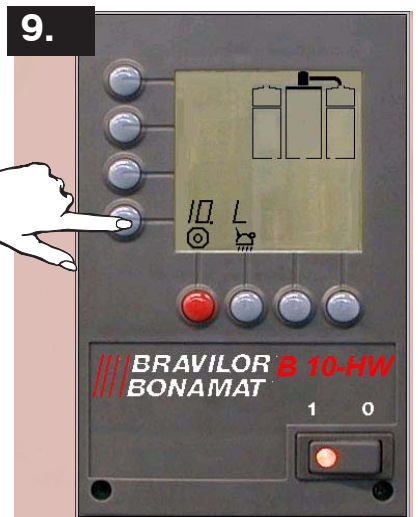
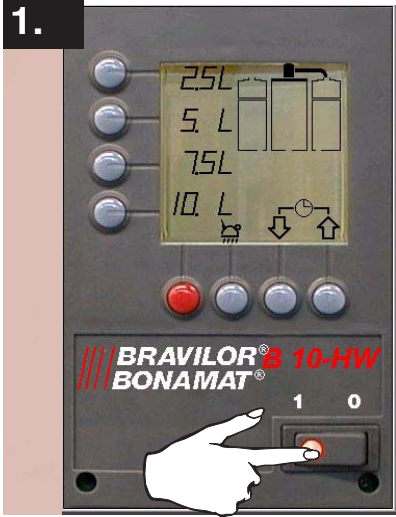

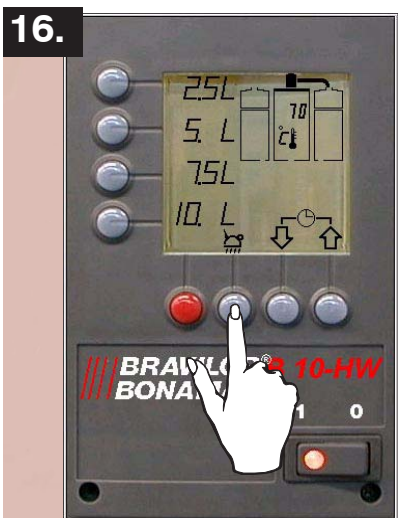

## 2. التنظيف، بشكل متكرر (BHW)

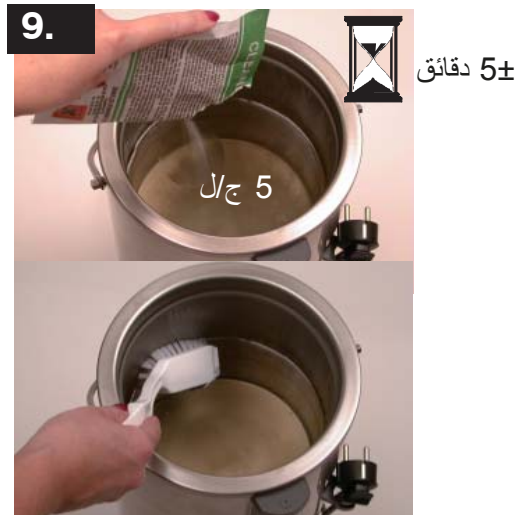
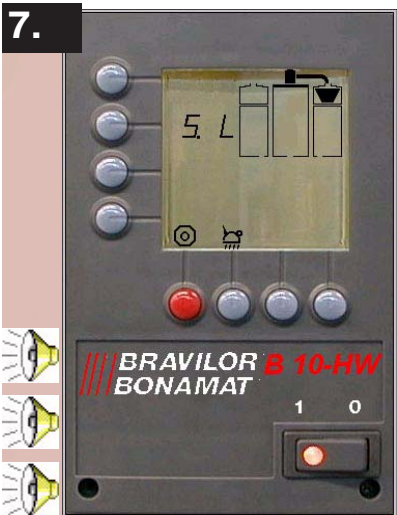
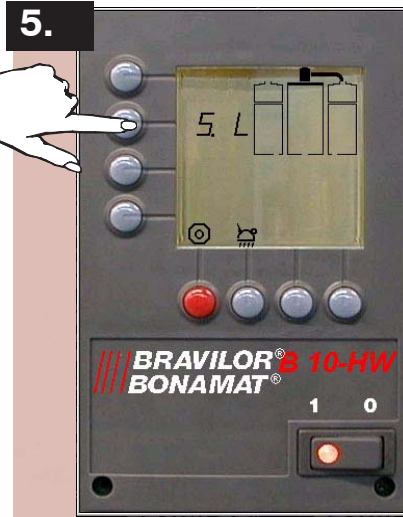
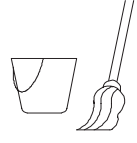

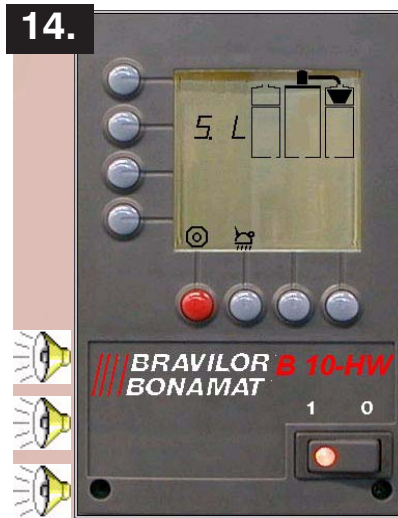
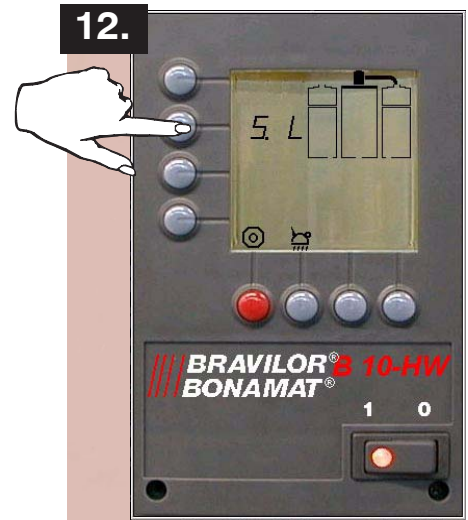







## 3. إزالة تكلس ماكينة تحضير القهوة (BHW) (المشغل)

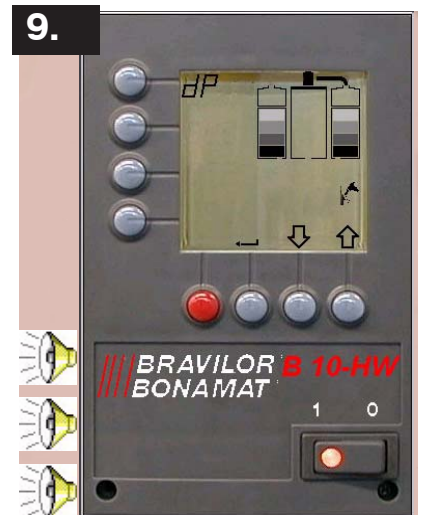
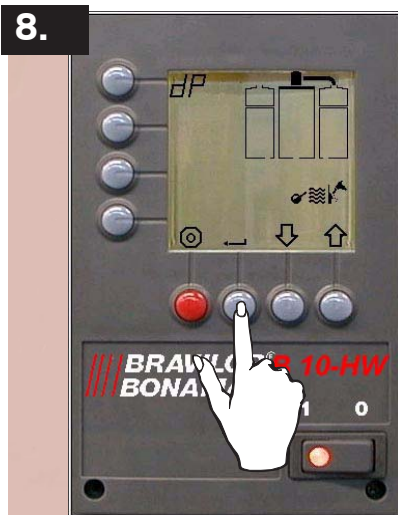
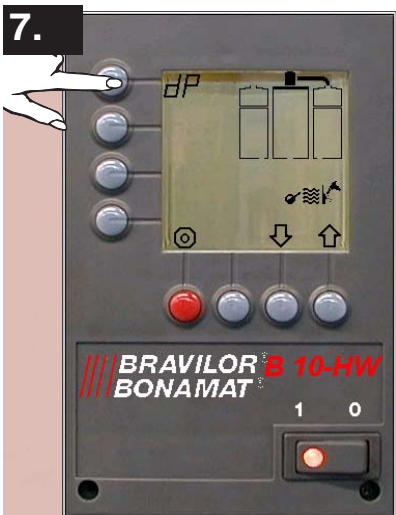
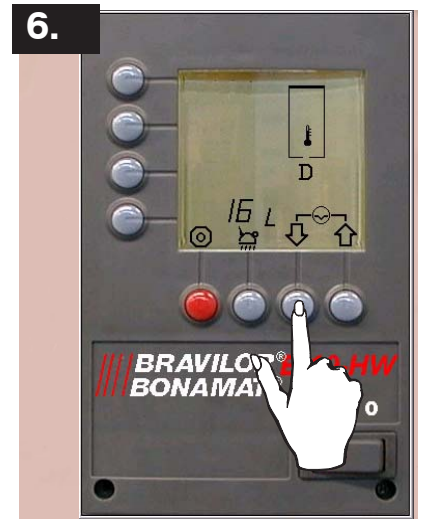
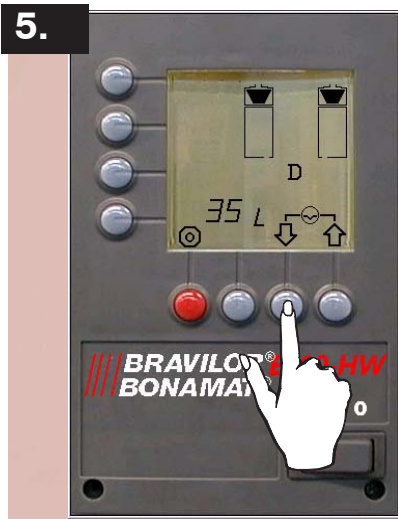
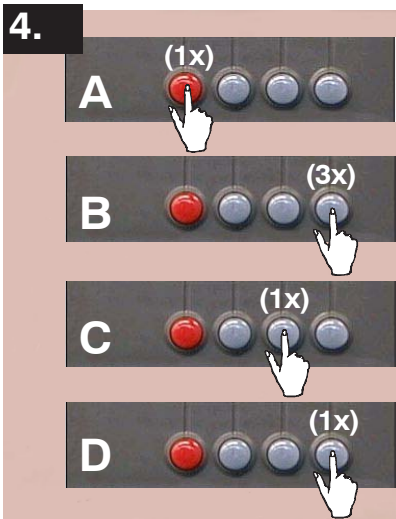

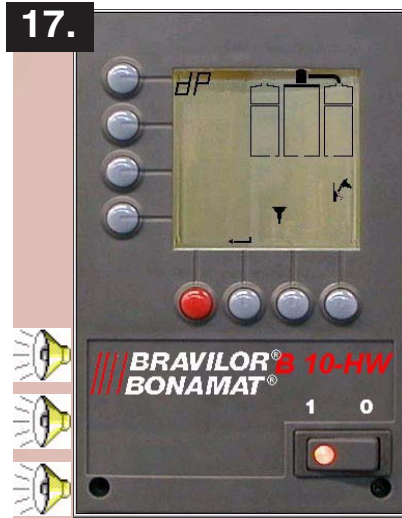
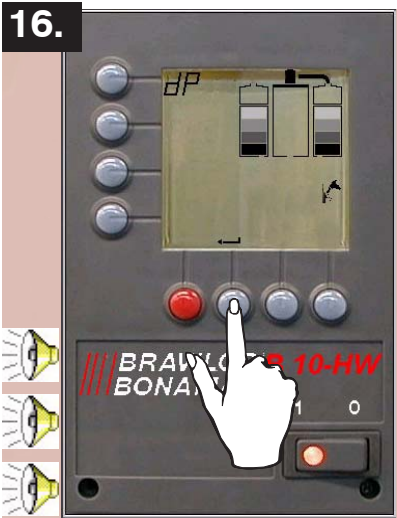
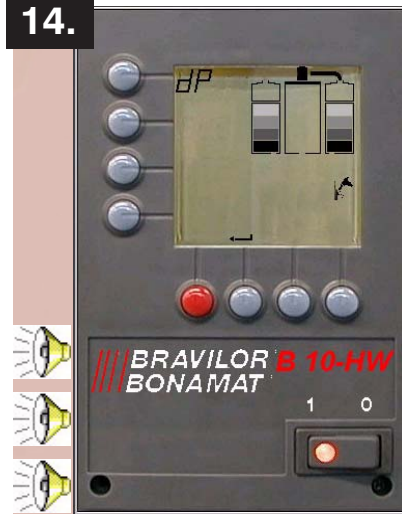
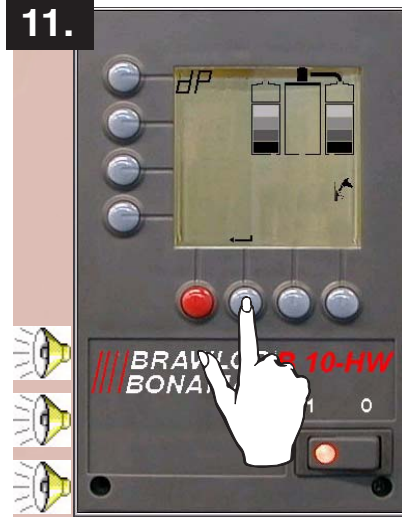



(°40 ±) ل 0.75 / ج 100

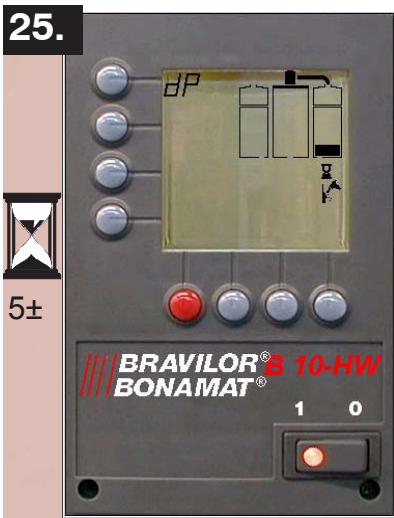
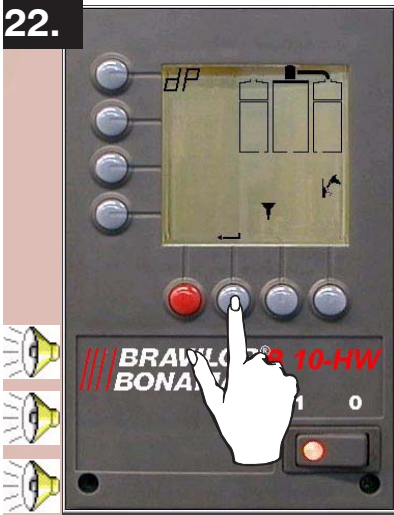

28.



29.



30.

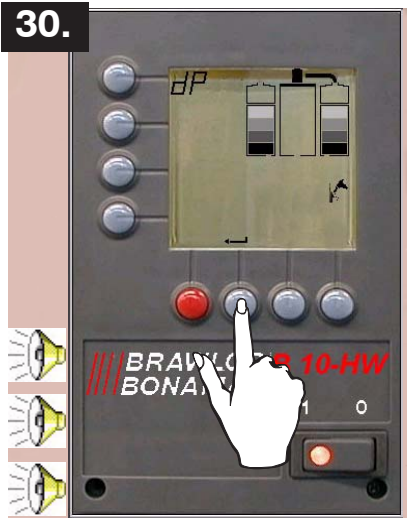

31.



32.



33.

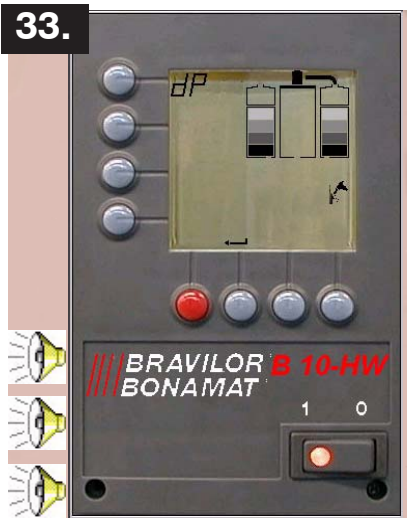

34.



35.

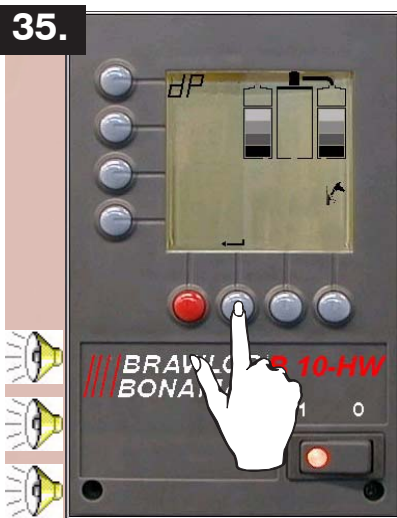

36.



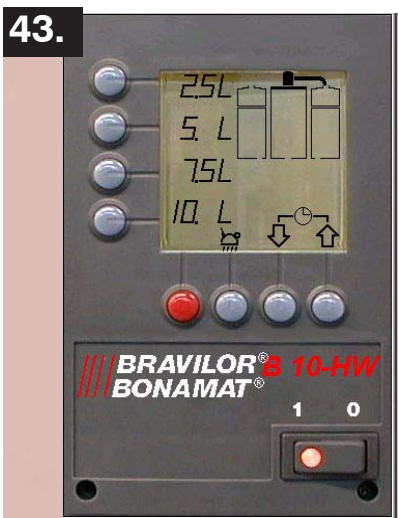
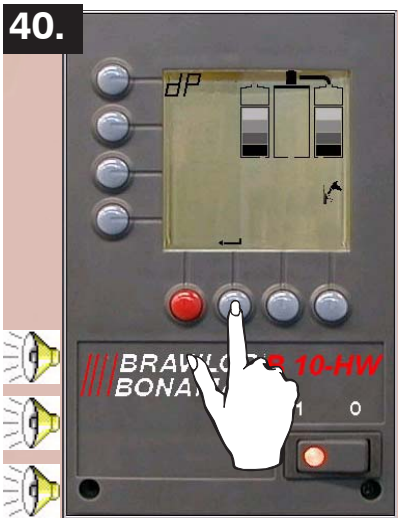
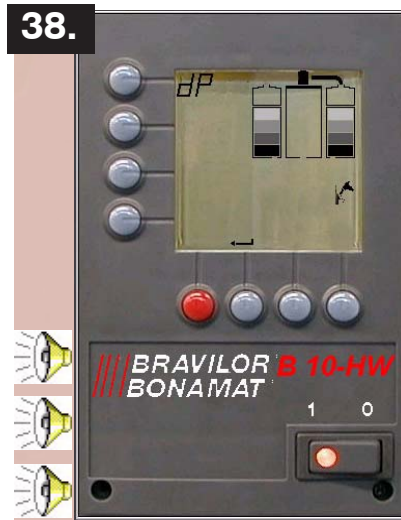

## 4. إزالة تكلس جهاز الماء الساخن (BHW) (المشغل)



(°40 ±) ل 1.00 / ج 100

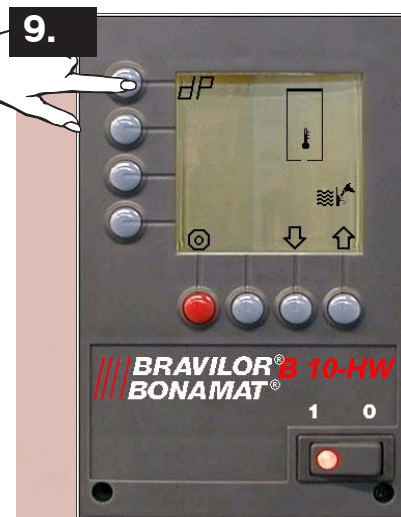
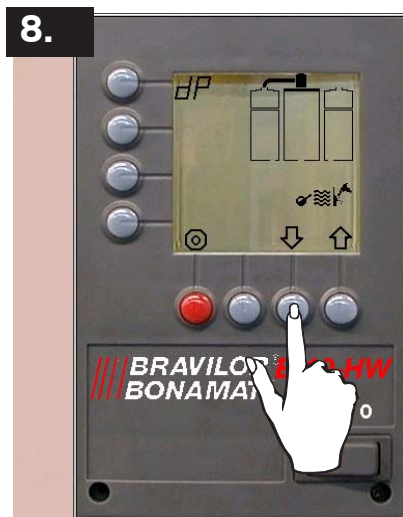
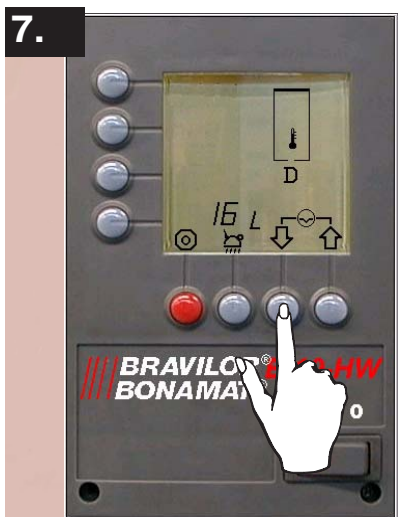
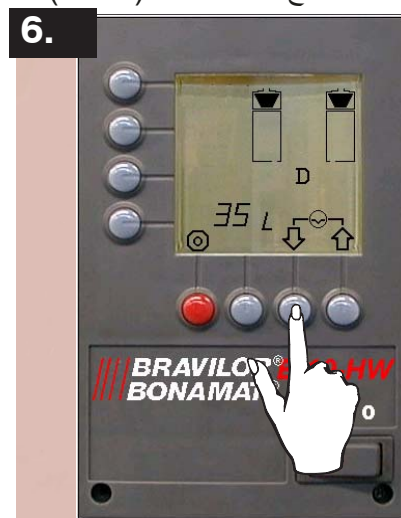
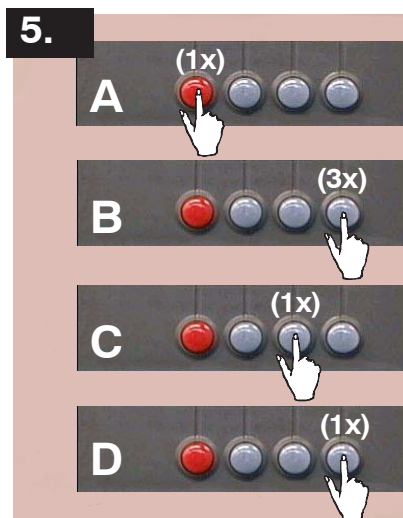

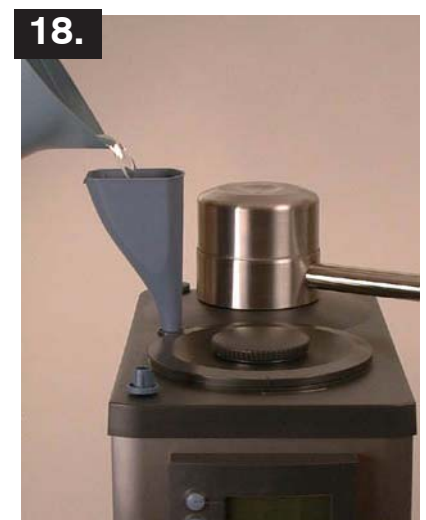
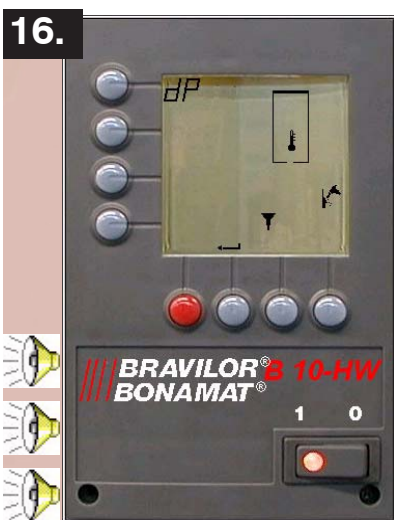
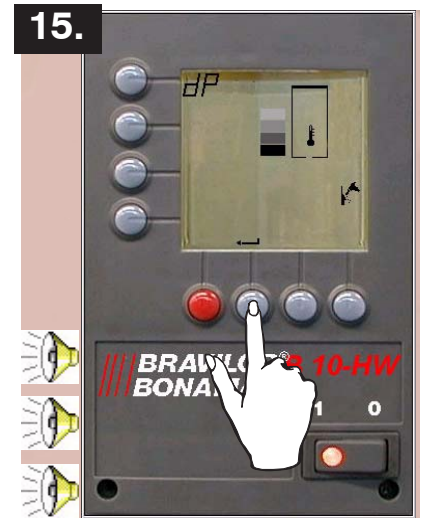
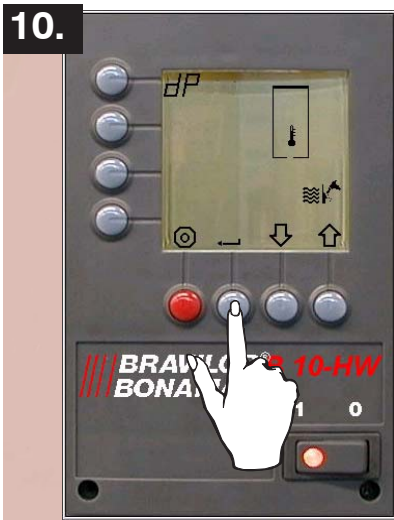

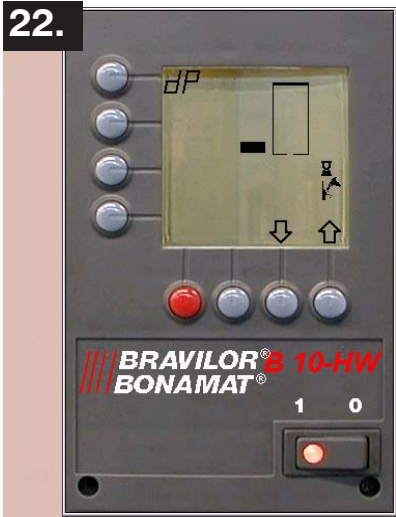
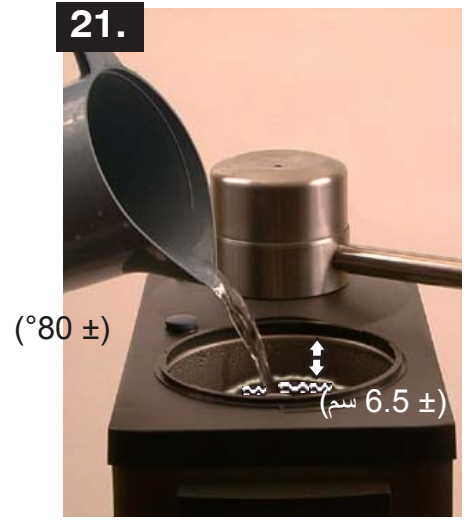
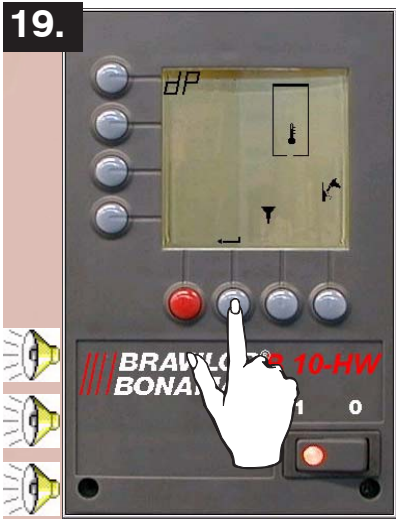



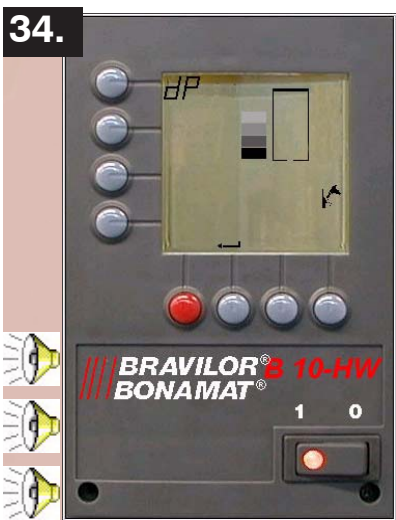
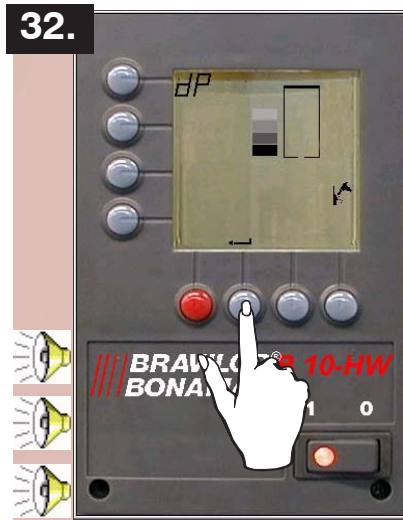

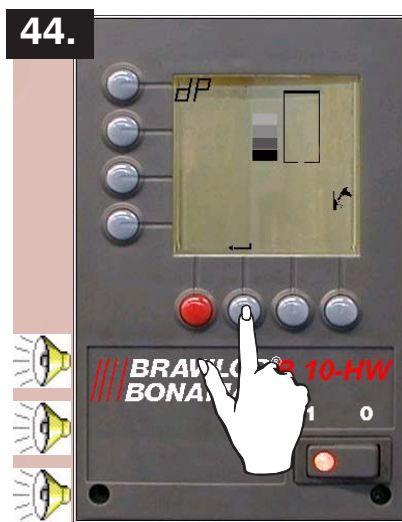
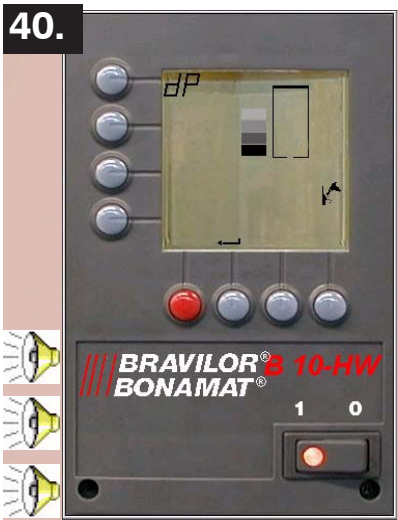
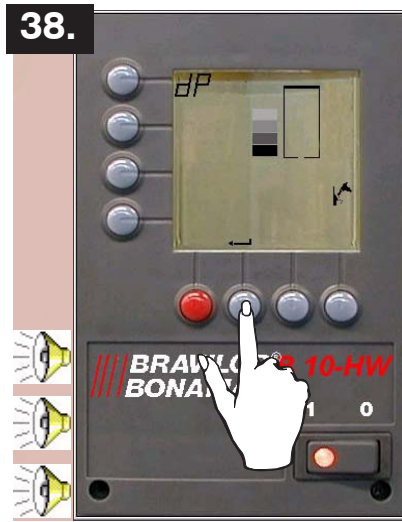

46.



47.





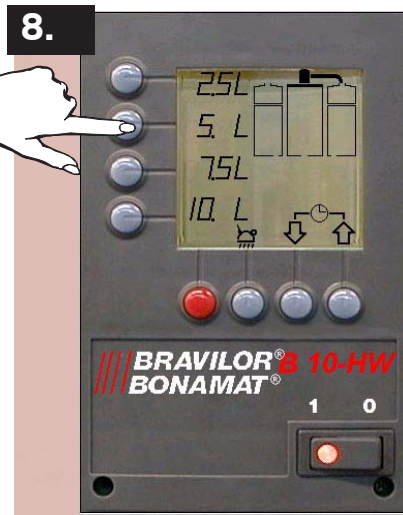
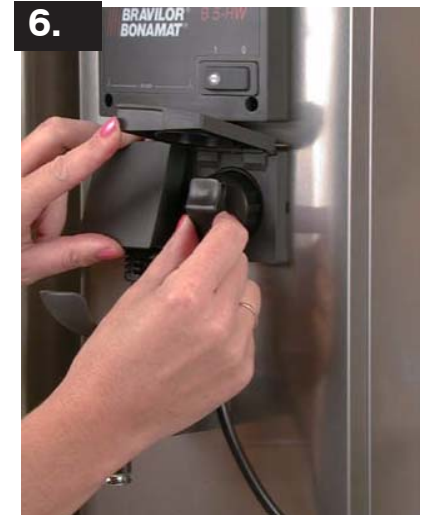
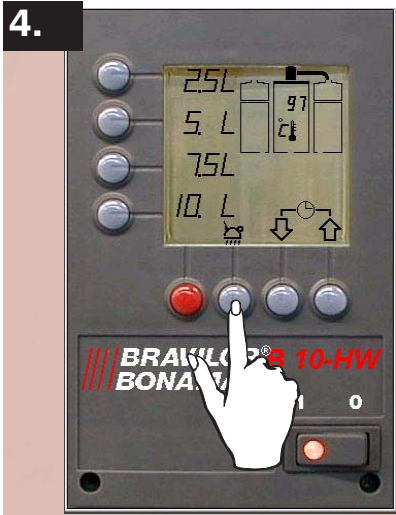
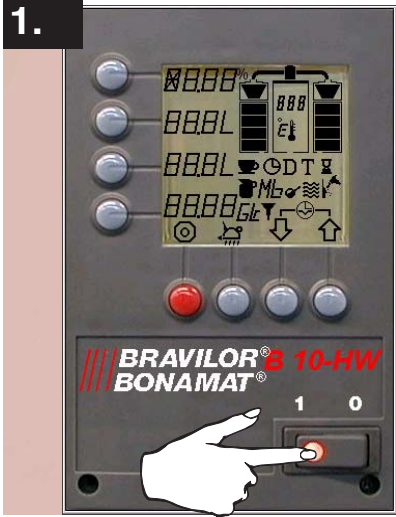

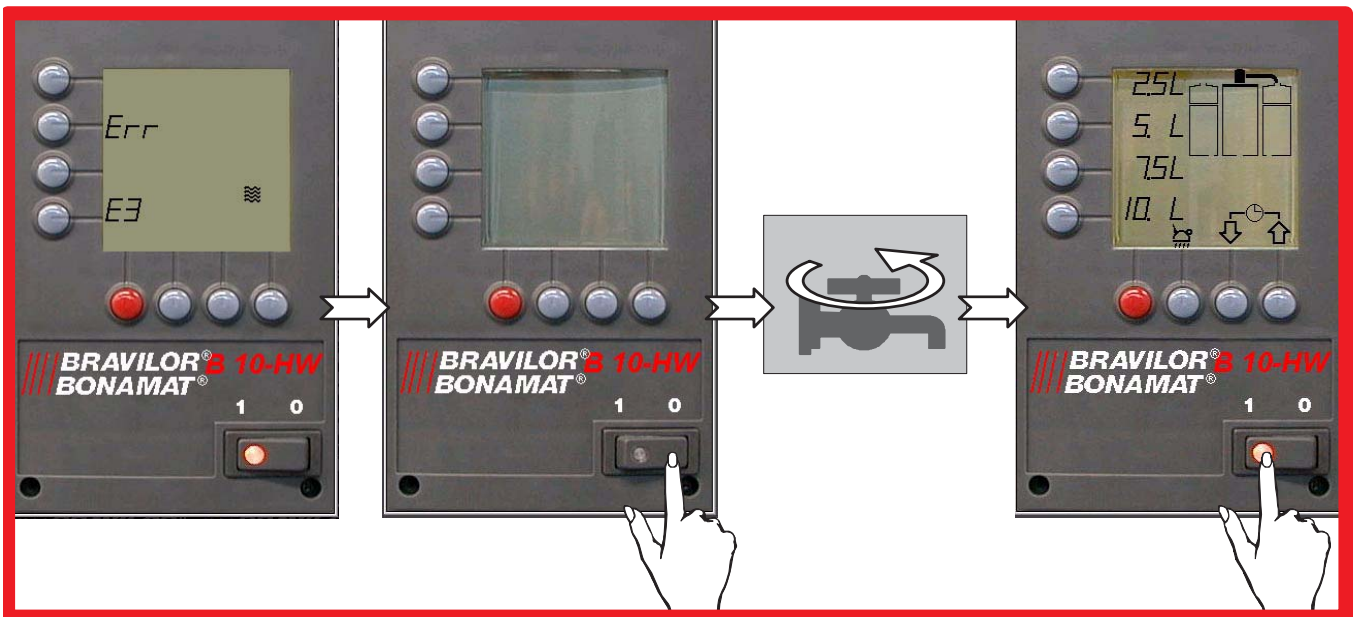
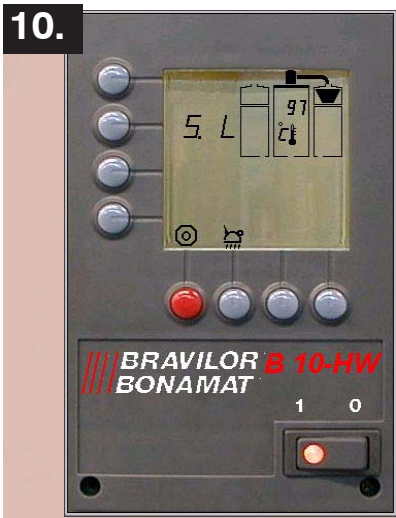



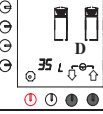

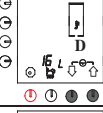

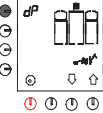



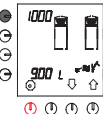

## 5. الاستخدام الأولي (BHW)

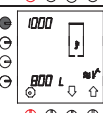

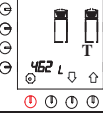

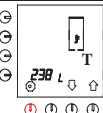
## 6. البرمجة (BHW) (المشغل)

				= 0
				
		§ 3.		
		§ 4.		
				
				
				
				
				

## .7 البرمجة (BHW)

(المستخدم الأساسي)

									<table border="1"> <tr> <td>B5 HW</td> <td>4.8</td> <td>5.3</td> <td>5.8</td> </tr> <tr> <td>B10 HW</td> <td>10.6</td> <td>9.6</td> <td>11.6</td> </tr> <tr> <td>B20 HW</td> <td>19.2</td> <td>21.2</td> <td>23.2</td> </tr> </table>	B5 HW	4.8	5.3	5.8	B10 HW	10.6	9.6	11.6	B20 HW	19.2	21.2	23.2																																																																					
B5 HW	4.8	5.3	5.8																																																																																							
B10 HW	10.6	9.6	11.6																																																																																							
B20 HW	19.2	21.2	23.2																																																																																							
									<table border="1"> <tr> <td>B5 HW</td> <td>1</td> <td>1</td> <td>3</td> <td>4</td> <td>5</td> <td>5</td> </tr> <tr> <td>B10 HW</td> <td>2</td> <td>2.5</td> <td>5</td> <td>7.5</td> <td>10</td> <td>10</td> </tr> <tr> <td>B20 HW</td> <td>4</td> <td>5</td> <td>-10</td> <td>-15</td> <td>-20</td> <td>20</td> </tr> </table> <table border="1"> <tr> <td>50</td> <td>125</td> <td>200</td> </tr> </table> <table border="1"> <tr> <td>B5 HW</td> <td>8</td> <td>8-24</td> <td>32</td> <td>40</td> <td>40</td> </tr> <tr> <td>B10 HW</td> <td>20</td> <td>20-40</td> <td>60</td> <td>80</td> <td>80</td> </tr> <tr> <td>B20 HW</td> <td>40</td> <td>40-80</td> <td>120</td> <td>160</td> <td>160</td> </tr> </table> <table border="1"> <tr> <td>50</td> <td>250</td> <td>3000</td> </tr> </table> <table border="1"> <tr> <td>B5 HW</td> <td>4</td> <td>4-12</td> <td>16</td> <td>20</td> <td>20</td> </tr> <tr> <td>B10 HW</td> <td>10</td> <td>10-20</td> <td>30</td> <td>40</td> <td>40</td> </tr> <tr> <td>B20 HW</td> <td>20</td> <td>20-40</td> <td>60</td> <td>80</td> <td>80</td> </tr> </table> <table border="1"> <tr> <td>B5 HW</td> <td>0.30</td> <td>0.30-0.65</td> <td>0.95</td> <td>1.30</td> <td>1.30</td> </tr> <tr> <td>B10 HW</td> <td>0.65</td> <td>0.65-1.30</td> <td>1.95</td> <td>2.60</td> <td>2.60</td> </tr> <tr> <td>B20 HW</td> <td>1.30</td> <td>1.30-2.60</td> <td>3.95</td> <td>5.25</td> <td>5.25</td> </tr> </table>	B5 HW	1	1	3	4	5	5	B10 HW	2	2.5	5	7.5	10	10	B20 HW	4	5	-10	-15	-20	20	50	125	200	B5 HW	8	8-24	32	40	40	B10 HW	20	20-40	60	80	80	B20 HW	40	40-80	120	160	160	50	250	3000	B5 HW	4	4-12	16	20	20	B10 HW	10	10-20	30	40	40	B20 HW	20	20-40	60	80	80	B5 HW	0.30	0.30-0.65	0.95	1.30	1.30	B10 HW	0.65	0.65-1.30	1.95	2.60	2.60	B20 HW	1.30	1.30-2.60	3.95	5.25	5.25
B5 HW	1	1	3	4	5	5																																																																																				
B10 HW	2	2.5	5	7.5	10	10																																																																																				
B20 HW	4	5	-10	-15	-20	20																																																																																				
50	125	200																																																																																								
B5 HW	8	8-24	32	40	40																																																																																					
B10 HW	20	20-40	60	80	80																																																																																					
B20 HW	40	40-80	120	160	160																																																																																					
50	250	3000																																																																																								
B5 HW	4	4-12	16	20	20																																																																																					
B10 HW	10	10-20	30	40	40																																																																																					
B20 HW	20	20-40	60	80	80																																																																																					
B5 HW	0.30	0.30-0.65	0.95	1.30	1.30																																																																																					
B10 HW	0.65	0.65-1.30	1.95	2.60	2.60																																																																																					
B20 HW	1.30	1.30-2.60	3.95	5.25	5.25																																																																																					
									<table border="1"> <tr> <td>88</td> <td>97</td> <td>97</td> </tr> </table> <table border="1"> <tr> <td>190</td> <td>206</td> <td>206</td> </tr> </table>	88	97	97	190	206	206																																																																											
88	97	97																																																																																								
190	206	206																																																																																								
									<p>▲ EnG</p> <p>■ dEu, FrA, ESP, nEd</p> <p>▲ - - - - - ■</p> <p>off on</p>																																																																																	





8. رموز الخطأ (BHW)

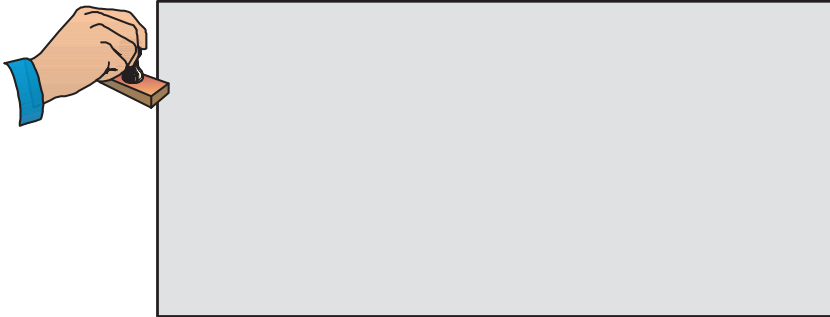
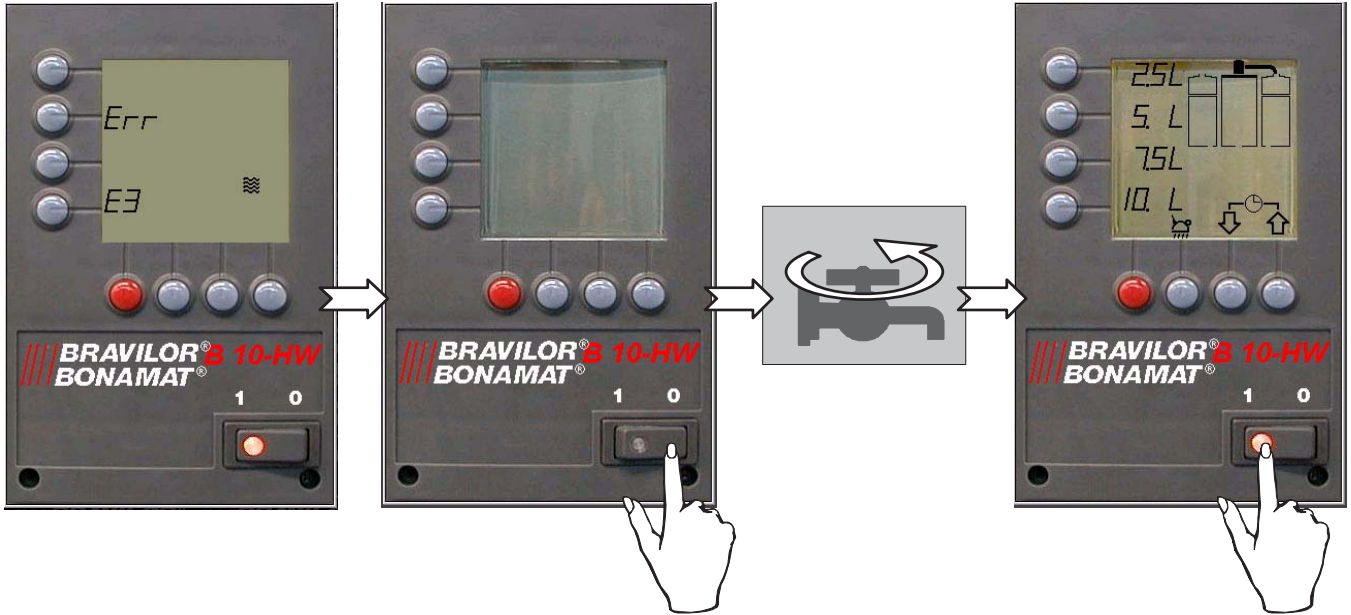



**BRAVILOR<sup>®</sup>**  
**BONAMAT**

ماكينات تحضير القهوة  
COFFEE BREWING MACHINES  
MACHINES A CAFE  
KAFFEEBRUEHMASCHINEN  
KOFFIEZETAPPARATEN

© 10 - 2015

700.403.772 A